

Varenummer: 20291150315R2SCR

Beskrivelse: E+G Lineære aktuatorer - GN 291.1-50-315-R2-SCR

Mål

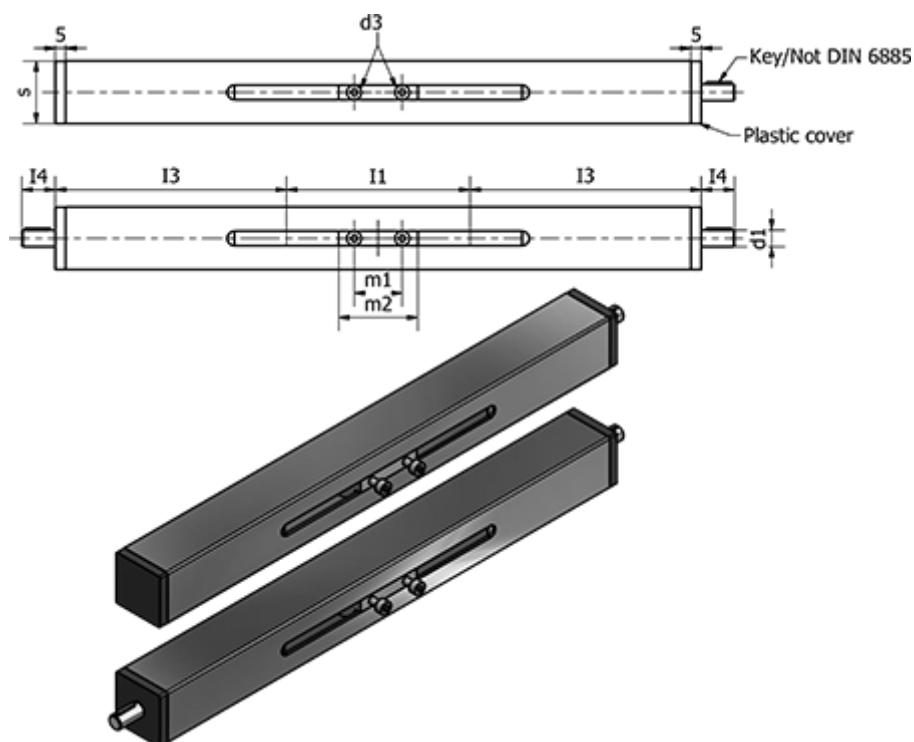

Aksel gevind = TR20x4

$d1$ f7 = 12

$d2$ = M6

$l1$ = 315

$l2$ = $l2+245$

$l3$ = 122.5

$l4$ = 18

$m1$ = 42

$m2$ = 54

Max. vandring = 1565

Not DIN 6885 = A4x4x12

s = 50